

ST25

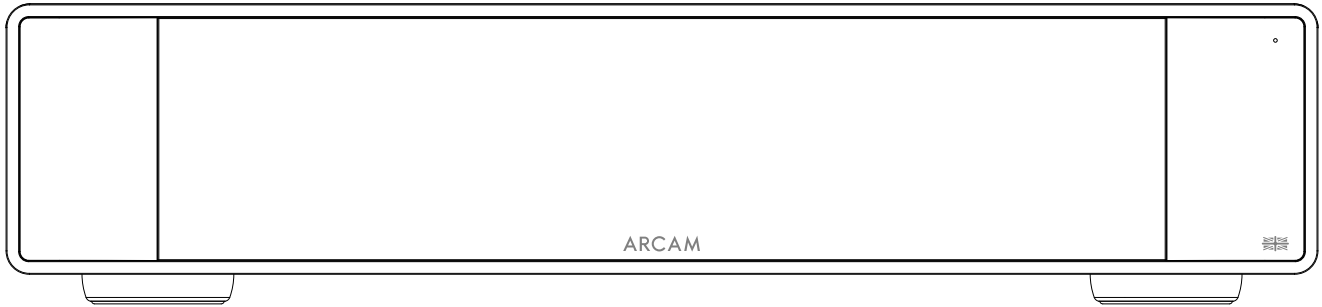

Owner's Manual

Download the setup app:





Not In China.



1. Read these instructions.
2. Keep these instructions.
3. Heed all warnings.
4. Follow all instructions.
5. Clean only with a dry cloth.
6. Do not block any ventilation openings. Install this apparatus in accordance with the manufacturer's instructions.
7. Do not install this apparatus near any heat sources such as radiators, heat registers, stoves or other apparatus that produce heat.
8. Do not defeat the safety purpose of the polarized or grounding-type plug. A polarized plug has two blades with one wider than the other. A grounding-type plug has two blades and a third grounding prong. The wide blade or the third prong is provided for your safety. If the provided plug does not fit into your outlet, consult an electrician for replacement of the obsolete outlet.
9. Protect the power cord from being walked on or pinched, particularly at plugs, convenience receptacles and the point where they exit from the apparatus.
10. Use only attachments/accessories specified by the manufacturer.
11. This equipment is designed for use in moderate climates with a maximum temperature of 35°C.
12. Use only with the cart, stand, tripod, bracket, or table specified by the manufacturer or sold with the apparatus. When a cart is used, use caution when moving the cart/apparatus combination to avoid injury from tip-over. 
13. Unplug this apparatus during lightning storms or when unused for long periods of time.
14. Refer all servicing to qualified service personnel. Servicing is required when the apparatus has been damaged in any way, such as when the power-supply cord or plug is damaged, liquid has been spilled or objects have fallen into the apparatus, or the apparatus has been exposed to rain or moisture, does not operate normally or has been dropped.
15. To disconnect this apparatus from the AC mains completely, disconnect the power-supply cord plug from the AC receptacle.
16. The mains plug of the power-supply cord shall remain readily operable.
17. This apparatus is intended to be used only with the power supply and/or charging cable provided by the manufacturer.

WARNING: TO REDUCE THE RISK OF FIRE OR ELECTRIC SHOCK, DO NOT EXPOSE THIS APPARATUS TO RAIN OR MOISTURE.

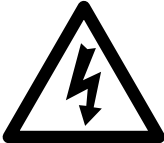
- Do not use this apparatus near water.
- Do not expose this apparatus to dripping or splashing, and ensure that no objects filled with liquids, such as vases, are placed on the apparatus.

CAUTION	
RISK OF ELECTRIC SHOCK. DO NOT OPEN.	
	THIS SYMBOL ON THE PRODUCT MEANS THERE IS UNINSULATED, DANGEROUS VOLTAGE WITHIN THE PRODUCT ENCLOSURE THAT MAY PRESENT A RISK OF ELECTRICAL SHOCK.
	THIS SYMBOL ON THE PRODUCT MEANS THERE ARE IMPORTANT OPERATING AND MAINTENANCE INSTRUCTIONS IN THIS GUIDE.

Visit the product page at ARCAM.co.uk and download the Safety Sheet for a full list of safety instructions.

Class II Product

This equipment is a Class II or double insulated electrical appliance. It has been designed in such a way that it does not require a safety connection to electrical earth ("ground" in the U.S.).

Front Cover - App Links

- ② **Important Safety Instructions**
- ③ **Table of Contents**
- ④ **Package Contents**
- ④ **Services**
- ④ **Placing The ST25**
- ⑤ **Front Panel**
- ⑤ **Rear Panel**
- ⑥ **Remote Control**
- ⑥ **Display Navigation**
- ⑦ **Connecting a Network**
 - Wired**
 - Wireless**
- ⑧ **Analogue Audio Connection**
- ⑨ **Control Setup**
- ⑩ **Operation**
- ⑪ **Menu**
- ⑪ **DAC Filters**
- ⑫ **Troubleshooting**
- ⑫ **Trademarks**
- ⑬ **Specifications**

ARCAM has been producing specialist Hi-Fi and home cinema products offering state of the art sound quality for over 45 years. The ARCAM ST25 is the latest in a long line of award-winning digital audio products extending back to our first CD player, the ARCAM Delta 70 in 1986, and the world's first separate DAC, the Delta Black Box in 1988.

The ARCAM ST25 provides an inclusive feature set supporting most smart phones and tablets, as well as popular streaming services.

In the unlikely event of any fault, or you require technical assistance, please contact our dedicated support teams by email at luxurysupport@harman.com, or by telephone using **+44 1707 668012** or **+1 888 691 4171**.

Or, if you simply require further information about ARCAM products, our network of dealers will be happy to help you. Further information can also be found on the ARCAM website at ARCAM.co.uk.

Package Contents

- ARCAM ST25 streaming music player
- IR remote
- 2x AAA batteries for the remote control
- Region specific power cords
- RJ11 control cable
- Quick start guide
- Safety and compliance document

Services

The ARCAM ST25 can be connected to, and play music from the following apps and services:

- Spotify Connect
- Tidal Connect
- Apple AirPlay
- Google Cast
- Roon (requires additional setup in Roon app)

Power Management

This product has user selectable functions related to power consumption. Changing these will change the power consumption of the product when in Standby:

- By default, the SA35 will enter standby within 20 minutes with no user interaction or playback. This can be disabled in the Menu by setting the **ECO Timer** to **Off**.
- By default, the SA35 network connections will remain active in standby. To reduce standby power consumption, all network connections, including Wi-Fi, can be disabled by setting **Network Standby** to **Off**.

Placing The ST25

- Place the streamer on a level, firm surface, avoiding direct sunlight and sources of heat or damp.
- Do not place the ST25 on top of an amplifier or other source of heat.
- Make sure the remote-control receiver to the left of the front panel display is unobstructed, otherwise this will impair the use of the remote-control.
- Do not place your record deck on top of this unit. Record decks are very sensitive to the noise generated by mains power supplies which will be heard as a background 'hum' if the record deck is too close.
- The normal function of the unit may be disturbed by strong electromagnetic interference. If this occurs, simply reset the unit with the power button, or move the unit to another location.

Front

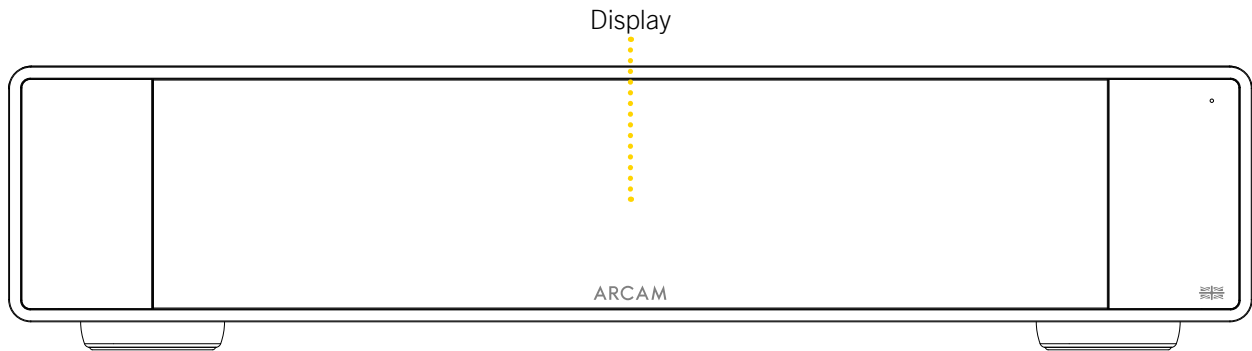

Rear

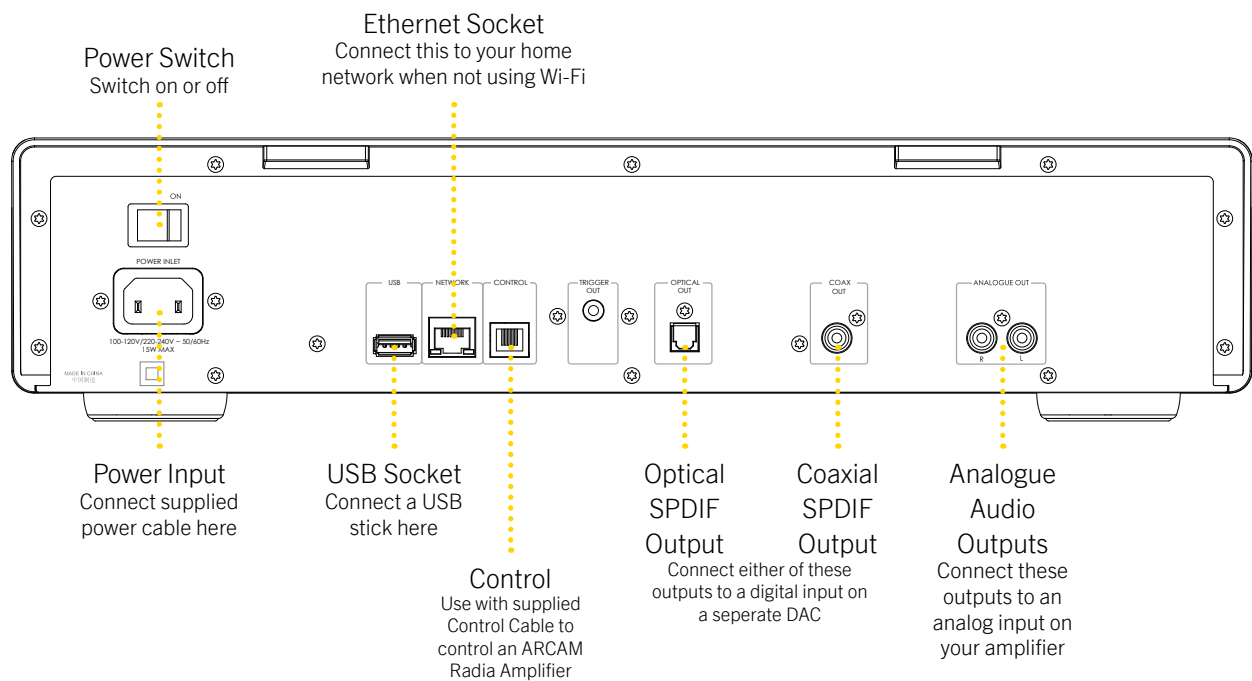

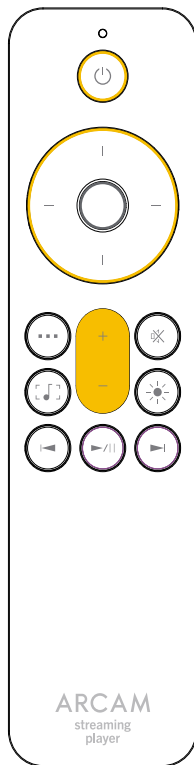

	Standby On/Off
	Menu Navigation Press the middle button to select
	Home Menu / Back
	Toggle Now Playing Display
	Transport Keys (Play/Pause, Skip back/forward)
	Volume Control
	Mute On/Off
	Display Bright/Dim/Off

Note: Incorrect use of batteries can have hazardous results. Do not mix old and new batteries together. Do not use non-identical batteries together. Although they may look similar, different batteries may have different voltages. Ensure the batteries are inserted in the correct direction.

Remove batteries from equipment that is not going to be used for a month or more. When disposing of used batteries, please comply with governmental or local regulations that apply in your country or area.

Display Navigation



- Navigate left to select a preset, or right for settings using

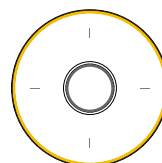

- Press the centre key to select, or the key to return.

Wired Network Connection

Ethernet Socket
Connect this to your home network
using a Cat 5e or Cat 6 cable

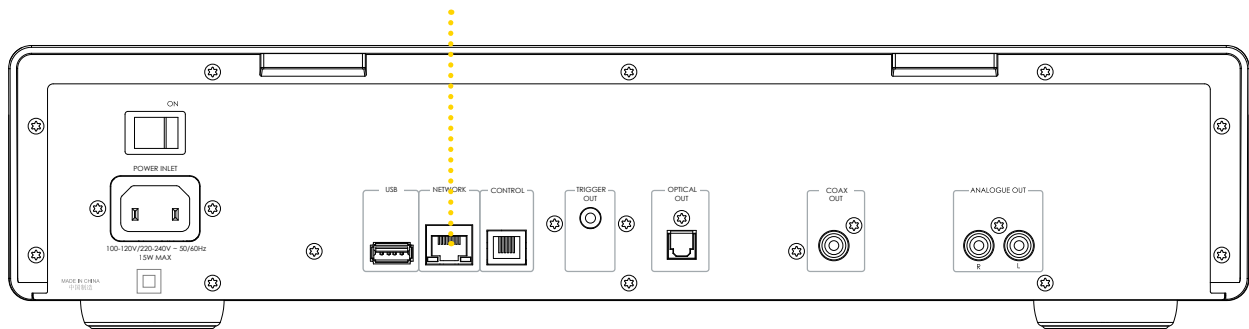

Wi-Fi Connection

- To make a Wi-Fi connection, download the [ARCAM Radia](#) app to your smartphone or tablet.
- Links to the app are on the front page of this manual.

Wi-Fi Setup - ARCAM Radia App

- Power on the ARCAM ST25 streamer and open the app to discover it after the ST25 is Ready.
- Select it and follow the prompts to connect it to your Wi-Fi router.
- When connected, the ST25 will appear with a “POWER” icon.
- Select the ST25 to access Podcasts, Internet Radio and presets, USB connected media, Local network storage (UPnP), and settings.

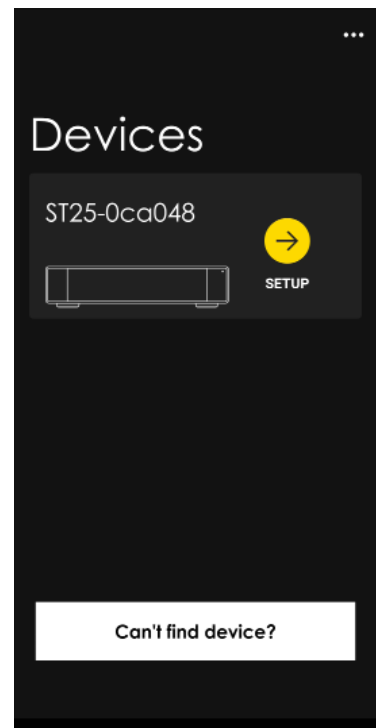

An audio connection must be made from the ST25 streamer to an amplifier. Analogue connections are preferable to guarantee sound quality of the ST25 is preserved. Follow these steps to make an audio connection:

1. Ensure power is disconnected from the Streamer and Amplifier.
2. Using analogue interconnect cables, connect the right (R), red terminal of the analog output on the streamer to the right (R), usually red terminal of an analog input on your amplifier.
3. Connect the left (L), white terminal of the analog output on the streamer to the left (L), usually white terminal of an analog input on your amplifier.

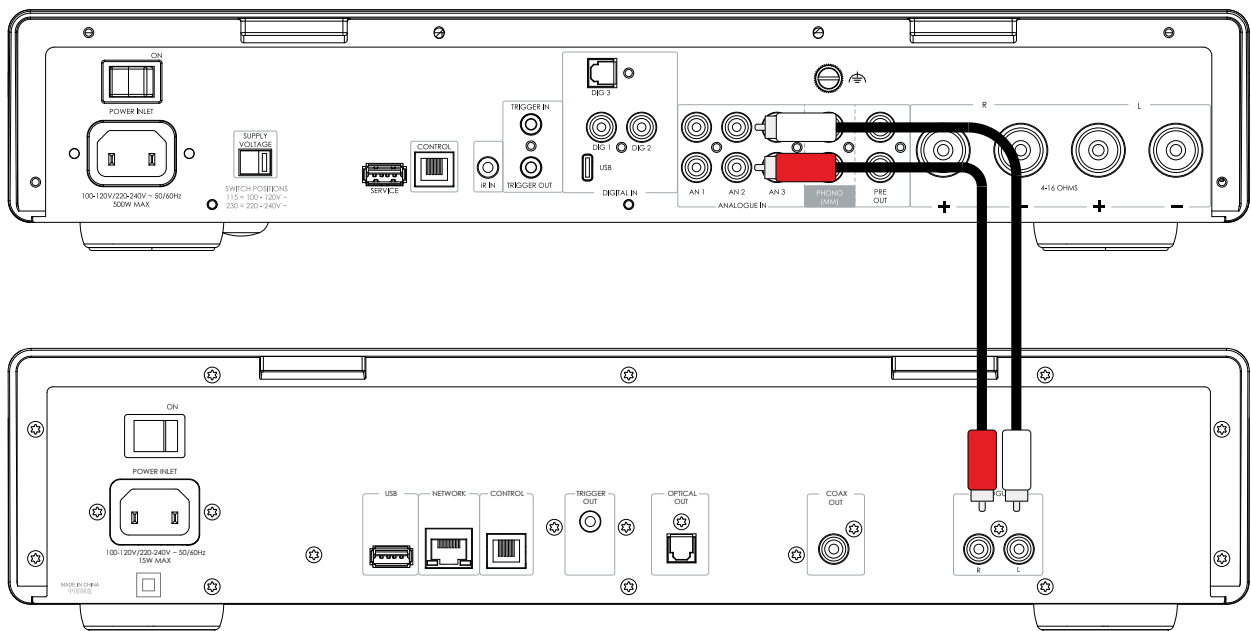

Top Tips

- After making connections, switch the amplifier on with no audio playing and reduce the volume to minimum. Select the input that corresponds to the connection used for the ST25, and then slowly increase the volume to a suitable listening level. This will avoid loud sounds or product damage in the event of incorrect connection.
- If you are unsure as to how your system should be connected, please contact your ARCAM dealer who will be happy to help you.

The Control connection allows for the ARCAM ST25 to synchronise with, and control an ARCAM Radia series amplifier (not SA35 or SA45). When streaming, it allows for the combination of streamer and amplifier to act as one.

Complete the following steps to enable this feature:

1. Ensure power is disconnected from the Streamer and Amplifier.
2. Connect either an analogue or digital audio connection from the output of the ST25 to an input of the ARCAM amplifier.

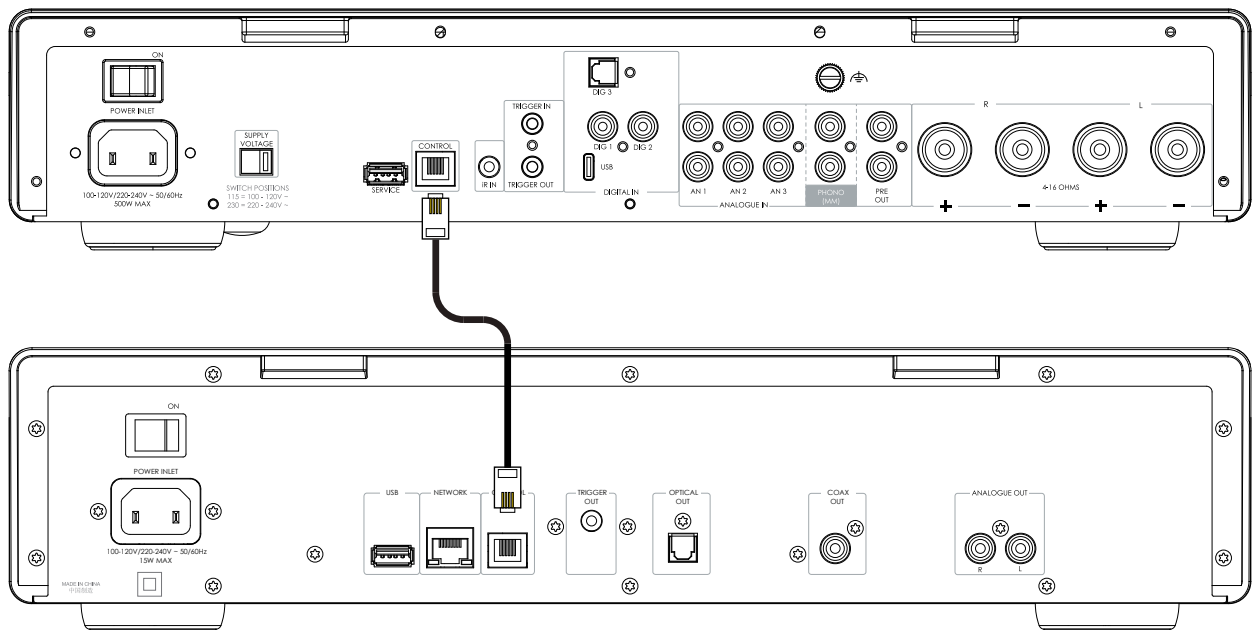

3. Connect the control cable from the ST25 CONTROL socket to the CONTROL socket on the ARCAM amplifier.
4. Power on both ST25 and ARCAM amplifier.
5. In the ST25 settings menu, set the **Volume Mode** option to **EXTERNAL**.
6. In the ST25 settings menu, set the **Output Type** to Analogue or Digital to match the audio connection type used.
7. In the ARCAM amplifier, set the **Streamer Input** option in the System Settings menu to match the input that you have connected the ST25 into.

Top Tips

- When the Volume Mode is set to Variable or External, there is a **Maximum External Volume** to prevent accidental excessive volume jumps. The default is **40**. This value can be changed in the menu of the ST25.

Power

The power switch on the rear panel switches the amplifier on or off. When you have finished making connections, switch the amplifier on.

Auto Standby

The ST25 is designed to enter standby automatically after 20 minutes with no audio playing, and no user interaction. This is to meet international power consumption regulations. This can be turned off in the menu. To use the menu, see page 11.

Streaming

The ARCAM ST25 can be connected to, and play music from the following apps and services:

- Spotify Connect
Use your phone, tablet or computer as a remote control for Spotify. Go to spotify.com/connect to learn how.
- Tidal Connect
- Apple Airplay
- Google Cast
- Roon (requires additional setup in Roon app)

From the ARCAM Radia app, you can access setup favorites and access other services including but not limited to:

- Internet Radio
- Podcasts
- Connected USB media
- Local network storage (UPnP)

USB

The ARCAM ST25 can play music files stored on a USB flash drive.

- Insert the USB storage device into the USB socket on the rear panel.
- Do not use a USB extension cable.
- Music files contained within the USB storage can be browsed using the ARCAM Radia app.

Supported Audio Formats

File Type	Bit Depths	Sample Rates
AAC	16 or 24 bit	44.1, 48, 88.2 or 96 kHz
AIFF	16, 24 or 32 bit	44.1, 48, 88.2, 96, 176.4, 192, 352.8, or 384 kHz
ALAC	16, 24 or 32 bit	44.1, 48, 88.2, 96, 176.4, 192, 352.8, or 384 kHz
FLAC	16, 24 or 32 bit	44.1, 48, 88.2, 96, 176.4, 192, 352.8, or 384 kHz
MP3	16 bit	44.1 or 48 kHz
OGG	16 bit	44.1 or 48 kHz
WAV	16, 24 or 32 bit	44.1, 48, 88.2, 96, 176.4, 192, 352.8, or 384 kHz
WMA	16 bit	44.1 or 48 kHz
DSD	1 bit	2.8224, 5.6448, or 11.2896 MHz

Menu

To access the setting menu, press  on the remote control.

To navigate the menu use the navigation buttons on the remote control.

Menu Tree

Menu Option	Description
Audio Output	Selects which output to use, Analogue or Digital. Default is Analogue .
Volume Mode	Selects whether the audio output volume is Variable, Fixed or External. Default is Variable .
Maximum External Volume	Defines maximum volume value sent to an ARCAM Radia series amplifier in External Volume mode. Default is 40 .
DAC Filter	Select a digital filter for the analogue outputs. Default is Linear Phase Apodizing .
Eco Timer	When enabled, the ST25 will enter standby within 20 minutes with no user interaction or playback. Default is On .
Network Standby	Selects whether the network connection is maintained in standby. Increases standby power consumption. Default is On .
System Reset	Press Select/OK to initiate a reset of all settings to default.
USB Update	Press Select/OK to initiate a software update from a USB stick present in the USB socket on the rear panel
Product Information	Displays SW versions, IP address and Network ID.

DAC Filters

The ST25 has the option to select between a number of digital filters that are used in the digital to analogue conversion process. Digital filters are required to minimise unwanted distortion in the output but no filter is perfect, there are always compromises between a few parameters:

1. Frequency response - audio level across audible frequencies. Ideally, this does not vary significantly between 20 Hz and 20 kHz.
2. Phase - The time delay introduced between reproducing different audible frequencies. Ideally, this would be as low as possible (linear phase).
3. Ringing - Additional audio artefacts that precede (pre) or follow (post) the audio. Ideally, these should be as low level and last for as short a time as possible.

The following filters are available for selection in the ST25:

Minimum Phase - Fast roll-off preserves output level to 20 kHz with no pre-ringing but extended post ringing.

Linear Phase Apodizing - A compromise between frequency response and ringing. Very slight reduction in output level of the highest frequencies. Pre and post ringing are equal and low in level.

Linear Phase Slow Roll-off - Measurable reduction in output level of the highest frequencies but pre and post ringing are equal, very short, and low in level.

Minimum Phase Slow Roll-off - Similar reduction in output level of the highest frequencies to Linear Phase Slow Roll-off. No pre-ringing and very little post ringing.

Troubleshooting

Problem	Check the following
No Sound	<ul style="list-style-type: none"> Is the streamer correctly plugged in and switched on? Is the audio output of the streamer correctly connected to the amplifier? Is the correct output selected (Analog or Digital)? (See Audio Output in menu above) Is the correct input selected on the amplifier? Is the amplifier muted?
The Streamer does not respond to the remote control	<ul style="list-style-type: none"> Does the light at the top of the remote control flash when the button is pressed? If not, replace batteries in the remote control. Are there fresh batteries in the remote control? Are you pointing the remote control towards the amplifier window without obstruction?
The front panel display is blank	<ul style="list-style-type: none"> Is the display dimmed to "Off"? Press  on the remote control to change the display brightness. Is the streamer correctly plugged in and switched on? Is the streamer in standby?
Cannot control the volume	<ul style="list-style-type: none"> Is Fixed volume enabled? (See Volume Mode in menu above) Is Digital output selected? (Volume Mode is automatically set to Fixed when Audio Output is set to Digital. See Audio Output and Volume Mode in menu above)
Cannot discover the streamer in an app	<ul style="list-style-type: none"> Is the streamer correctly plugged in and switched on? Does the streamer have a network connection, wired by Ethernet or Wi-Fi? For Wi-Fi connections, has setup been completed using the ARCAM Radia app? Is your smartphone or tablet connected to the same local network? For Google Cast, ensure Google Terms are accepted in the ARCAM Radia App.

Trademarks and Licenses



Apple®, AirPlay® and the AirPlay Logo™ are trademarks of Apple Inc., registered in the U.S. and other countries. App Store is a service mark of Apple Inc. To use AirPlay with the ARCAM ST25, the latest version of iOS, iPadOS, or macOS is recommended.



Google Cast and YouTube Music are trademarks of Google LLC.



The Spotify Software is subject to third party licenses found here: <https://www.spotify.com/connect/third-party-licenses>



The Tidal word mark and logo are registered trademarks owned by Tidal Music AS.



Qobuz is a trademark of Xandrie SA.



Being Roon Ready means that ARCAM uses Roon streaming technology, for an incredible user interface, simple setup, rock-solid daily reliability, and the highest levels of audio performance, without compromise.



The Wi-Fi CERTIFIED™ logo is a registered trademark of Wi-Fi Alliance®.

Services	
Works with (apps)	ARCAM Radia Spotify Connect Tidal Connect Roon
Works with (services)	Apple Airplay Google Cast
ARCAM Radia supported services (Global)	Internet Radio Podcasts UPnP USB Media (using USB-A mass storage input)
Audio Section	
Supported media:	FLAC, WAV (LPCM), AAC, ALAC, AIFF, DSD (up to 256), M4A, MP3, OGG, WMA
Supported Bit depth:	16, 24, 32
Supported sample rates (kHz):	Up to 384 kHz
Gapless Playback:	Yes
Digital Audio Outputs	1x Coaxial (RCA), 1x Optical (Toslink)
Analogue Audio Outputs	1x Stereo (RCA) pair
Wireless Specification	
Wi-Fi Network	IEEE 802.11 a/b/g/n/ac (2.4GHz/5GHz)
2.4G Wi-Fi Transmitter Frequency Range and Power	2400-2483.5 MHz (USA 11 Channels, Europe and Others 13 Channels): <20dBm
5G Wi-Fi Transmitter Frequency Range and Power	5150-5250 MHz <23dBm 5250-5350 MHz <20dBm 5470-5725 MHz <20dBm (Not in China) 5725-5850 MHz <14dBm
BLE Transmitter Frequency Range and Power	2400-2483.5 MHz, <10dBm
General	
Mains voltage	100-120V/220-240V 50/60Hz
Power consumption	15W
Power consumption (Network standby)	<2W
Power consumption (Eco standby)	<0.5W
Dimensions W x D (including speaker terminals) x H (including feet)	432 x 329 x 99mm
Weight (net)	5 kg
Weight (packed)	7 kg
Supplied accessories	Mains lead(s) Remote control with 2 x AAA batteries Control Cable Quick Start Guide Important Safety Instructions

Restrictions in the 5 GHz band: According to Article 10 (10) of Directive 2014/53/EU, the packaging shows that this radio equipment will be subject to some restrictions when placed on the market in Belgium (BE), Bulgaria (BG), the Czech Republic (CZ), Denmark (DK), Germany (DE), Estonia (EE), Ireland (IE), Greece (EL), Spain(ES), France (FR), Croatia (HR), Italy (IT), Cyprus (CY), Latvia (LV), Lithuania(LT), Luxembourg (LU), Hungary (HU), Malta (MT), Netherlands(NL), Austria(AT), Poland (PL), Portugal (PT), Romania (RO), Slovenia (SI), Slovakia (SK),Finland (FI), Sweden (SE), the Turkey (TR), Norway(NO), Switzerland (CH), Iceland (IS), Liechtenstein (LI), and the United Kingdom in respect of Northern Ireland (UK(NI)).

The 5150 to 5350 MHz frequency range is restricted to indoor use. This equipment should be installed and operated with a minimum distance of 20cm between the product and your body.

Use Restrictions: This device is restricted to indoor use when operating in the 5150 to 5350 MHz frequency range in the following countries:

	BE	EL	LT	PT	
	BG	ES	LU	RO	
	CZ	FR	HU	SI	
	DK	HR	MT	SK	
	DE	IT	NL	FI	
	EE	CY	AT	SE	
	IE	LV	PL	UK(NI)	

Belgium (BE), Greece (EL), Lithuania(LT), Portugal (PT), Bulgaria (BG), Spain(ES), Luxembourg (LU), Romania (RO), Czech Republic (CZ),France (FR), Hungary (HU), Slovenia (SI), Denmark (DK), Croatia (HR), Malta (MT), Slovakia (SK), Germany (DE), Italy (IT), Netherlands(NL), Finland (FI), Estonia (EE), Cyprus (CY), Austria(AT), Sweden (SE), Ireland (IE), Latvia (LV), Poland (PL), Northern Ireland (UK(NI)).

ARCAM

www.arcam.co.uk

ARCAM is a trademark of HARMAN International Industries, Incorporated, registered in the United States and other countries.

© 2024 HARMAN International Industries, Incorporated. All rights reserved.

Features, specifications, and appearance are subject to change without notice.



HARMAN International Industries, Incorporated.

8500 Balboa Boulevard, Northridge, CA 91329 USA

EMEA Liaison Office: Danzigerkade 16G 1013 AP Amsterdam, Netherlands

UK Business Address: Ground Floor, Westside 2, London Road, Apsley, Hemel Hempstead, Hertfordshire, HP3 9TD, United Kingdom
